

Chippewa County, Michigan

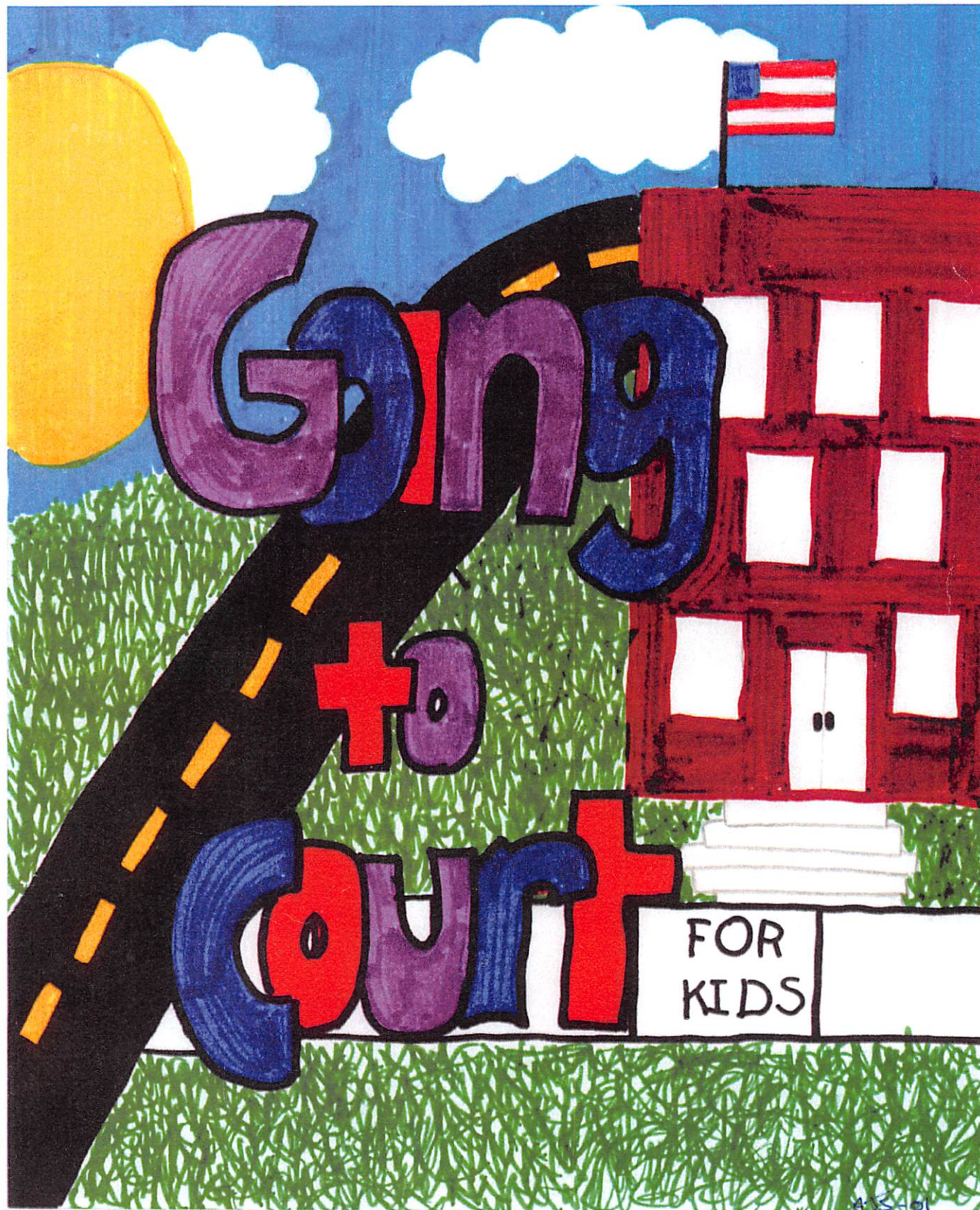

THIS BOOK
BELONGS TO:

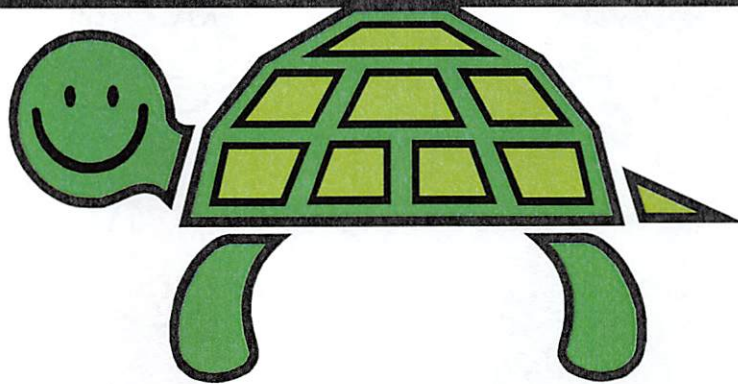

When I go to court

WHERE
DO I
GO..?

MOVIE
THEATRE

THE
MALL

PLAYGROUND



GROCERY
STORE

ZOO

COURTHOUSE

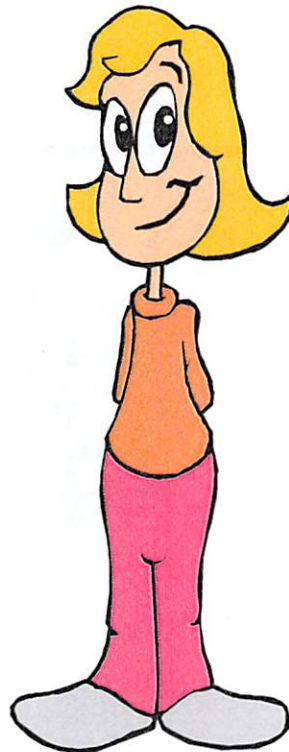

SCHOOL

CIRCLE THE ANSWERS YOU THINK ARE RIGHT

STATE OF MICHIGAN
COUNTY OF CHIPPEWA



91st JUDICIAL DISTRICT
50th JUDICIAL CIRCUIT

SUBPOENA

Case No.
COMP NO.
Person Requesting Subpoena:
Brian A. Pepler, Chippewa County Prosecutor
300 Court Street
Sault Ste. Marie, MI 49783
(906) 635-6342

Court Address: 325 Court Street Sault Ste. Marie 49783

People of the State of Michigan v.

Charge:

In the Name of the People of the State of Michigan TO:

YOU ARE ORDERED to appear personally at the time and place state below.
You may be required to appear from time to time and day to day until you are excused.

Thursday, 06/10/2010 at 9:00 AM

YOU ARE ALSO ORDERED TO:

Testify at: District Court Jury Trial

Produce the following items:

Other:

You are under subpoena until the Court or the Prosecutor excuses you. Failure to appear as ordered may subject you to penalties for contempt of court.

NOTICE: You are also REQUIRED to CALL the Prosecuting Attorney's office at (906) 635-6342 the day before you are scheduled to appear after 5:00 p.m. and before 8:00 a.m. A recorded message will inform you if the case is going or has been adjourned. This call in service is provided for your convenience.

If you are required to appear for the schedule court matter, please present your copy of the subpoena to the court at the window.

If you require special accommodations to use the court because of disabilities, please contact the court immediately to make arrangements. Thank you in advance for your assistance.

Date: 05/25/2010

← Where you go

← Date and Time

← Please Call

Before you have to come to court you will get a paper like this one. It is called a subpoena. It will have your name on it and will tell you

- where you have to go
- what day you have to go
- what time you have to go

Be sure to bring this paper with you when you come to court.

The detective you talked to will also get a subpoena for court and will meet you there.



My Detective's Name Is:

Chippewa County Sheriff and State Police



Circuit Court

Court House

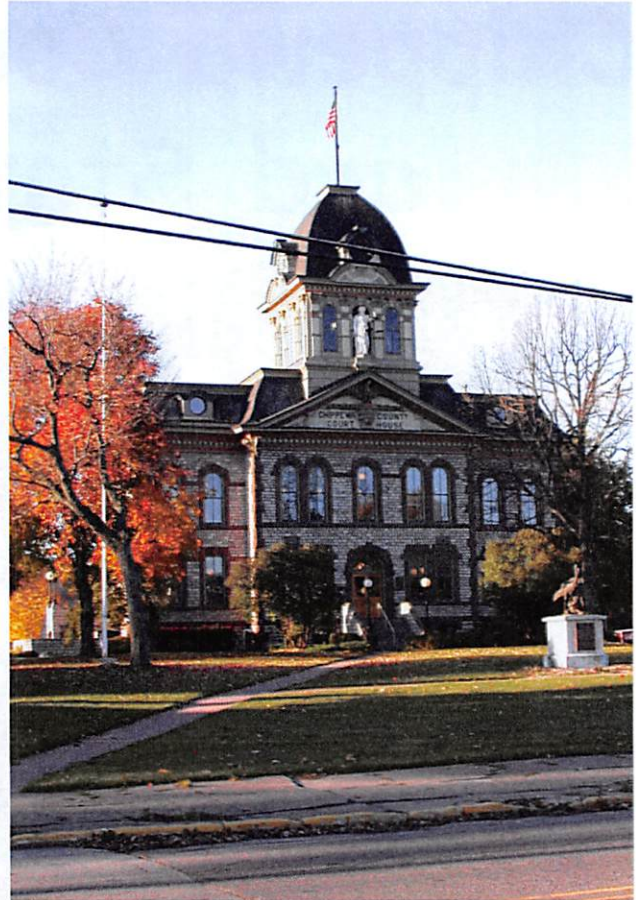

91st District Court



City & County Building

Color the picture of the courthouse



Courtroom



Circuit Courtroom



District Courtroom

When I go to court

WHO WILL I MEET...?

POLICE OFFICER

DOCTOR

BUS DRIVER

TEACHER



JUDGE

ELEPHANT

ATTORNEY

FRIEND

MAILMAN



CIRCLE THE ANSWERS YOU THINK ARE RIGHT

Prosecutors



The Prosecutors try to make sure that someone is held responsible when they hurt somebody.

Victim Advocate



The person who tells the victim and the witnesses about the court and answers any questions they may have. You can also tell this person if you are afraid or worried about anything.

Court Reporters



The Court Reporter writes down everything that is said in the courtroom

Bailiff



Makes sure the courtroom rules are obeyed.

Witness

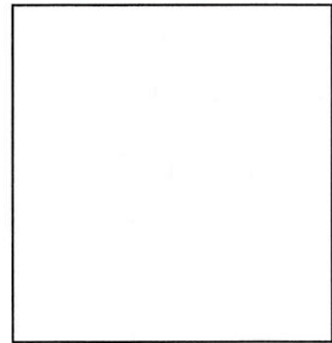

Draw yourself here



A person who saw the crime happen or who knows something about the crime.

Defense Attorney



The lawyer who helps the person accused of breaking the law. He or she asks the witness questions in court.

Defendant

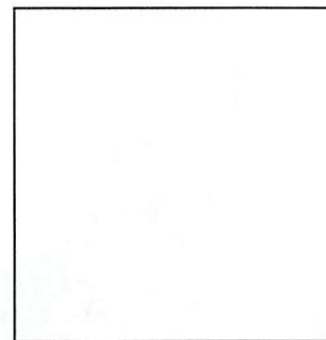

The person accused of breaking the law.



The Judge

The person who sits in the highest chair, wears a black robe and is in charge of the courtroom.



When I go to court

WHAT
DO I
DO?

THINK

EAT

WATCH



SING



LISTEN



TALK

DANCE

PLAY

RUN

BE QUIET

CIRCLE THE ANSWERS YOU THINK ARE RIGHT

TELL WHAT REALLY HAPPENED TELL THE TRUTH !

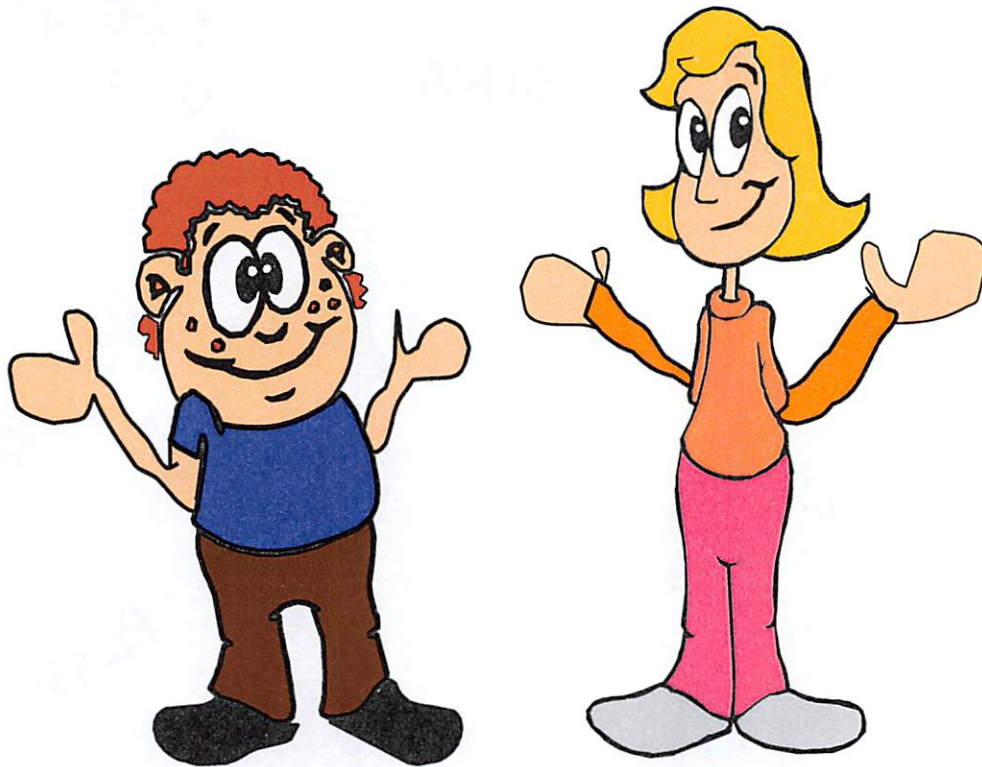

The truth is what happened. It is right. It is good to tell the truth.

A lie is something that did not happen. It is wrong. It is not good to tell a lie.

This is an airplane.

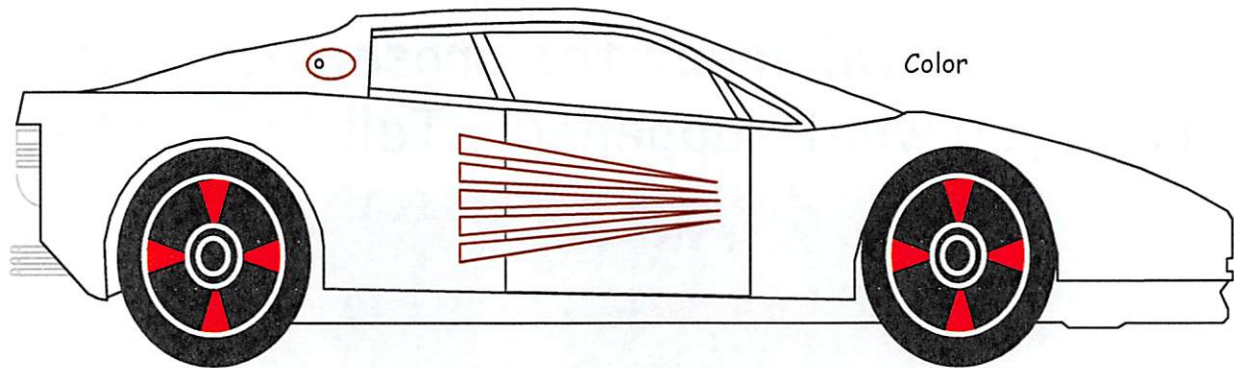

Truth

or

Lie?

Maze

Start

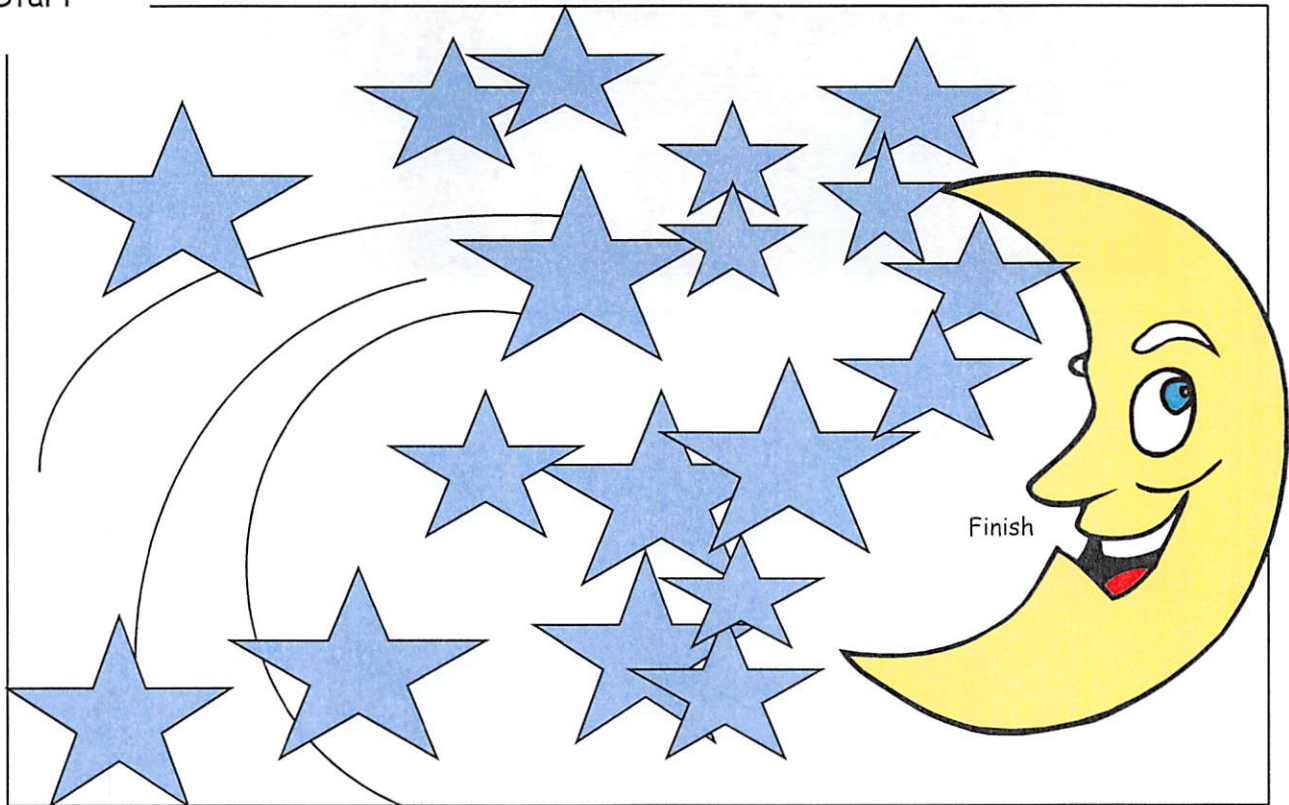

When the stars & moon are out - it is nighttime.

Truth

or

Lie?

First: You will meet with your advocate.

Second: You will meet the prosecutor who will ask you what happened... Tell the truth.



Draw a picture of you with your Prosecutor

Then:

You will go into the courtroom and the judge will ask you to promise to tell the truth.

The prosecutor will ask you questions.

The defense attorney will ask you questions.

The judge may also ask you some questions.

Tell all of them the truth.

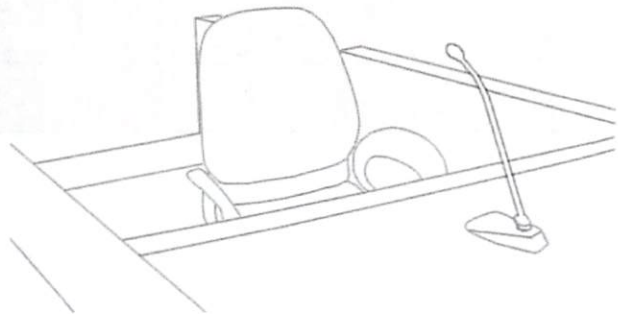

Draw a picture of yourself on the Witness Chair

Later on, you may have
to come back to court
to tell a jury what
happened



The jury hears all the witnesses
and then decides if the defendant
is guilty or not guilty.

If it is decided the defendant is guilty, the judge decides what sentence the defendant will get.

You may want to come back to court one last time and tell the judge what you think the defendant's punishment should be and what special help the defendant should get.

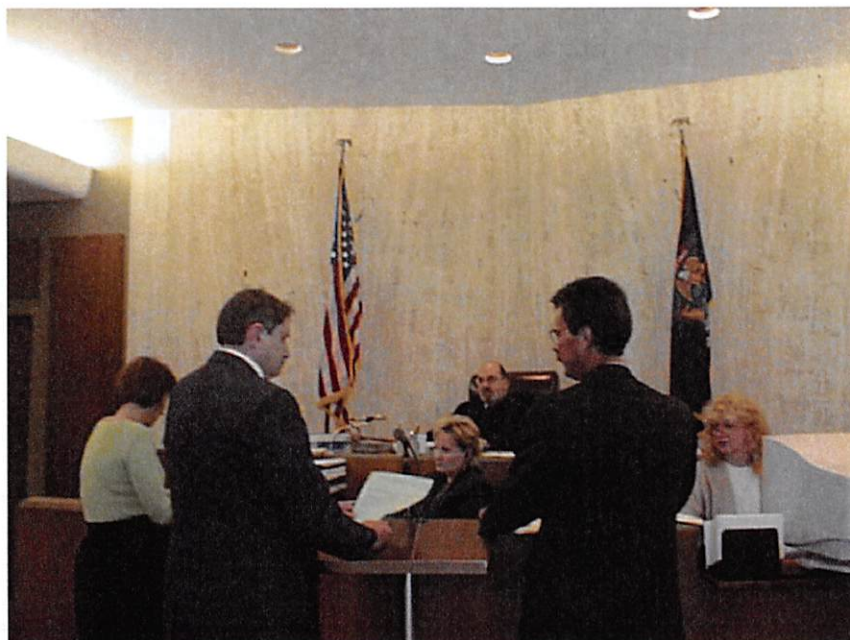

Remember:

If you ever have a question or something has you worried, call your victim advocate.

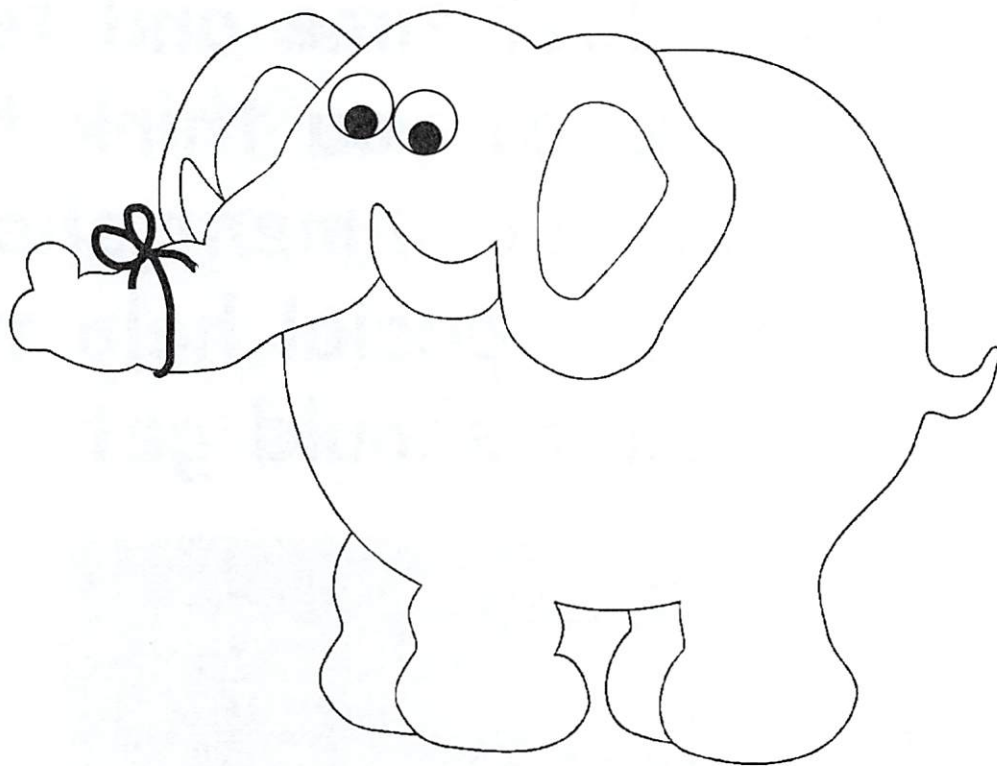

You will not see one of these in the courtroom

Name: _____

Phone: _____

Match the Word with the Right Sentence



Judge	The person who tells the victim and the witnesses about court and answers questions. You can tell this person if you are afraid or worried.
Jury	The person who tries to show a judge or jury that the defendant broke the law.
Witness	The person accused of breaking the law.
Sentence	A person who saw the crime happen or knows about the crime.
Defendant	In court, the person who helps the defendant.
Victim Advocate	The person who sits in the highest chair in the courtroom and wears a black robe.
Prosecutor or Prosecuting Attorney	The people who hear all the witnesses and then decide if the defendant is guilty or not guilty.
Defense Attorney Or Defendant's Attorney	The punishment or special help the Judge says the defendant will get.

Thank you for
helping.



YOU ARE A HERO!



Chippewa County

319 Court Street

(906) 635-6330 FAX (906) 635-6325

Sault Ste. Marie, Michigan

Brian A. Pepler

Chippewa County Prosecuting Attorney

Chippewa County Courthouse Annex

300 Court Street

Sault Ste. Marie, MI 49783

Phone: 906-635-6342

Fax: 906-635-6850

Special Thanks to Ruth Stephen and the Kent County
Victim/Witness Unit for the creation of the booklet and allowing
us to reproduce it.

Created by: Cheryl Jones

With assistance from

Erin L. Huber & Rachel L. Skym

Publication of this booklet was made possible through funding
provided by the State of Michigan Crime Victim Services Commission

May be reproduced without permission for non-commercial use only



BYE!